

# A closer look at TS1 LO.

Discoveries & differences  
found during restoration of TS1.



TS1 information contained in this pamphlet was compiled through first-hand knowledge obtained from previous owners, historical records and restoration evidence. This booklet is for informational purposes only.

# *TS1 LO was mounted and commissioned by Standard-Triumph*

Motor Company at their Banner Lane factory in the summer of 1953 for display at the annual Canadian Motor Show in Toronto the following October. The car's only function was to give the Canadian public a chance to see the company's new TR2 sports car; beyond that, TS1 was surplus to requirements. After the show, TS1 was driven for a time by the president of the Canadian branch of Standard-Triumph, and then sold on to private hands. As far as Standard-Triumph was concerned, TS1 was history.

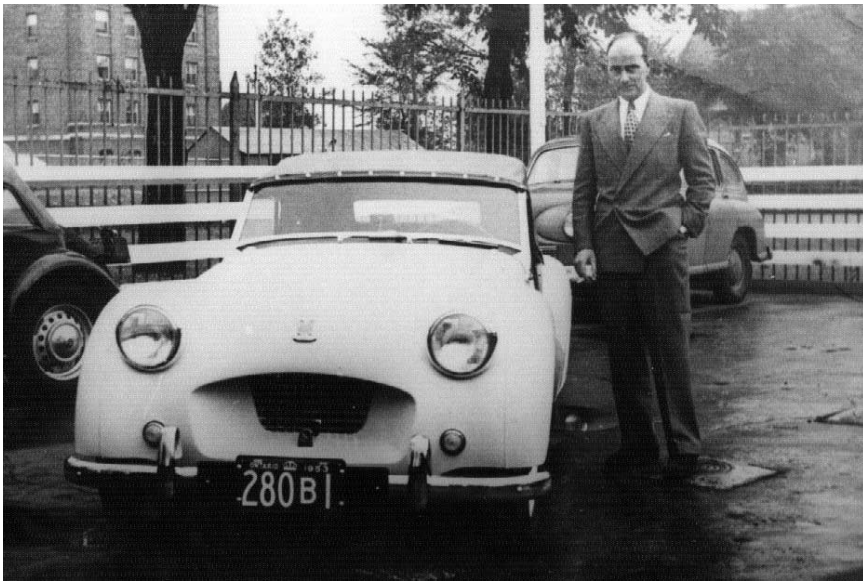

**Mr. C.D.S. Phillips, President of the Canadian Branch of Standard-Triumph, taking delivery of TS1 prior to the Canadian Car Show. TS1 was driven from Montreal to Toronto.**

**Photo from the Canadian Auto show 1953 (TS1 on center platform).**



## **SPARE TIRE DOOR**

TS1 has a more narrow spare tire door, made from aluminum and not embossed with license plate area. This was a recall item for the first 30 or so cars (or until wire wheels were introduced as an option). TS1's door configuration did not accommodate a wire wheel so later cars have taller doors and frame modifications.



## **BABY TENAX**

These original baby fasteners were re-chromed and finish washers were machined to match the original washers.



## **FAN SPINDLES**

When it came time to install the radiator to TS1, it was found that TS1's fan spindle was shorter than other TR2 spindles. It was known that early TR2s used a shorter spindle than later ones, but TS1's spindle was even shorter.



## **HINGES**

Bonnet and boot hinges were made from brass, they were bigger and painted the bonnet color.



**STONE GUARDS**

TS1's stone guards are larger and wider and more round to accommodate rounder, wider rear fenders.



**DOOR CAPPINGS**

Discovered on the underside, marked "Canadian" for TS1, designating parts for car going to Toronto car show. (remember they were building TS2 at the same time side by side)

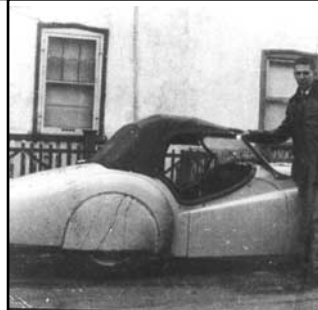

**REAR FENDER WINGS**

Rear fenders were hand-formed wider and more round on the edges than square, like later TR2s.

**BATTERY TIE DOWN**

Welded wire

**REAR WHEEL SPATS**

Spats for rear wheel openings (an option for early TR2s). Note in photo the poor seal on spats, this photo was taken with TS1's first owner, so fit was poor from the start.



Joe Richards  
TS1 LO owner,  
restorer and first  
President of TRA.

Now, 23 years after TS1 made its way to Ohio, it is once again a working TR2. The restoration process was long and often quite frustrating for Joe, but he persevered and now, fifty years after TS1 was first assembled at Banner Lane, he has brought the first "production" TR2 back to life. For the Triumph community, the restoration of TS1 marks the closing of a TR circle that began so many years ago; for Joe, TS1 is the culmination of a lifelong commitment to the preservation of Triumph TRs. Today you will see TS1 as the Canadian public saw it for the first time in Toronto in October 1953, and through your own knowledge of TRs, track the numerous engineering and detail changes that set this very special car apart from the TRs you're familiar with. Learn from Joe what it took to restore the car, and what he had to learn along the way to do so. TS1 is now a living testament to the way things were done in the British automotive industry in the early 1950s. Enjoy the opportunity to see and hear of it first hand!

*TS1 LO restoration process* was to restore rather than replace, whenever possible...that meant many parts would be saved and reconditioned, then reused on TS1. Though replacement parts may have been available and a much easier way to go. Joe held steadfast to the originality of TS1.



**TS1 FACTORY BUILD RECORD**



TS1 Badge front

TS1 Badge back

**APRON MEDALLION**

At first glance, TS1's badge doesn't look that different, the badge is definitely larger and heavier in your hand. But to notice the real secrets of the badge you have to turn it over and examine the backside (see photo and illustration on upper right). On the backside of the medallion you would see that the badge was constructed from a Standard 8 badge pieced together and re-enameled to resemble a TR2 badge design as we know today.

The colors on the badge are reversed (black field and red field) in the open book area. Also, the area with the word Triumph is not enameled with a red background. This medallion was truly the "first prototype" for the TR2 badges as we know them today.

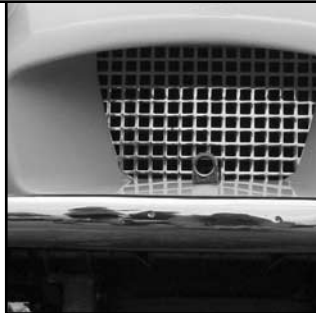

**TS1 FRONT GRILL**

The grill on TS1 is cast out of brass, as well as, the sidecurtian door brackets and sidecurtain frame wedges, as opposed to being made from aluminum like later TR2s.

**BONNET**

TS1 bonnet is 100% aluminium, the bonnet also does not have rivets, normally seen on early TR2 bonnets.

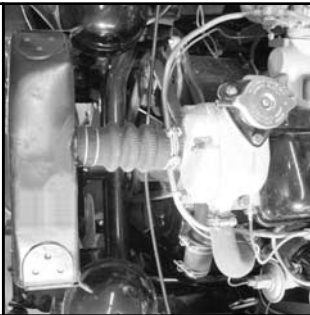

**THERMOSTAT HOUSING**

This item was one of the early design changes made through a recall for the first 1,201 TR2s. This service recall replaced the radiator with a long fill neck. If you look closely TS1 is fitted with a radiator that does not have a fill neck, rather it has a fill cap that is located on the thermostat housing, just as it would have appeared prior to the service recall.



**RADIATOR LOWER PIPE**

(water tube) This configuration is slightly different than other TR2s, the piping run is made mostly of curved metal and short straight hoses, rather than, the near straight metal pipe and curved hoses used in later TRs.



**WIRING HARNESS**

Located a new old ORIGINAL wiring harness and sub-harness for headlights and sidelights. The old harnesses were too worn to be reused.



**COMMISSION PLATE**

Plate placement different than later TR2s.

**FLASHER UNIT**

Location of flasher unit different than later TR2s.

**INTAKE MANIFOLD**

Cast with part number, somewhat unusual.

**TS1 LO frame modifications** while many of these frame changes were minor, they are the foundation to a accurate restoration. TS1's frame was too rotted to restore, so a very early TR2 replacement frame was used, while this was an early frame, changes still were needed. The modifications were mostly removals of pieces, more than additions. This makes sense in that the original frame was a starting point for the TR2 and as production of TR2s continued and service issues arose so did additions to the original TR2 frame.

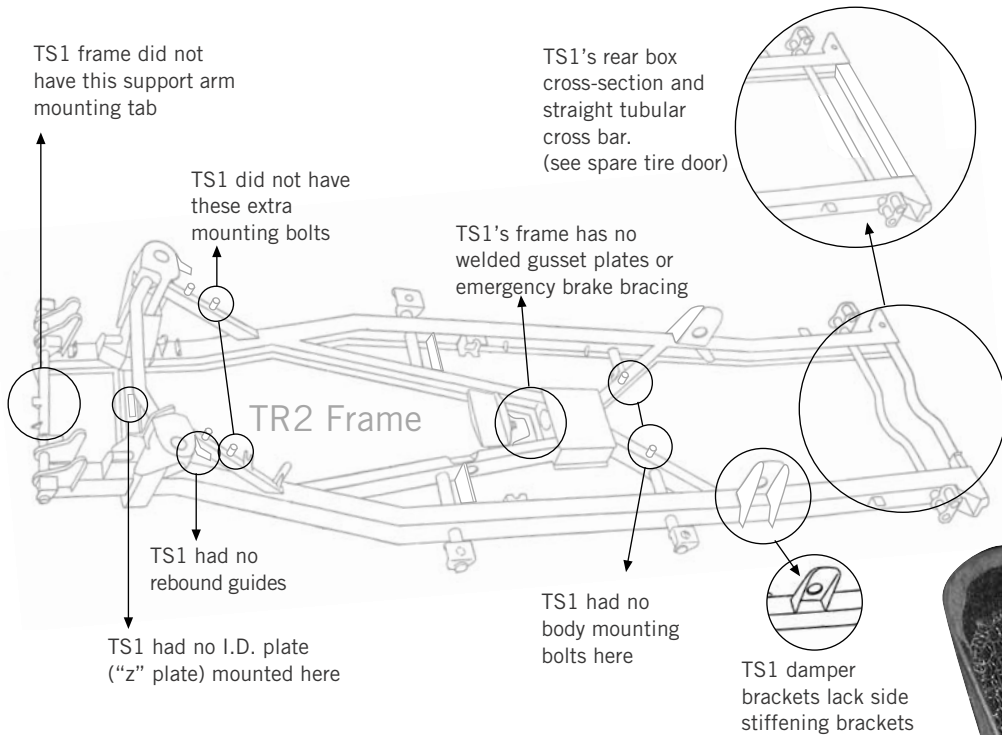

**FIRST PLACEMENT OF MASTER CYLINDER**

This bulkhead patch shows a change made in the placement of the master cylinders. This area actually shows up in the photos used in the original

TR2 maintenance manual. TS1 was the TR2 model for many of the manuals service diagrams. See inset factory photo at left.

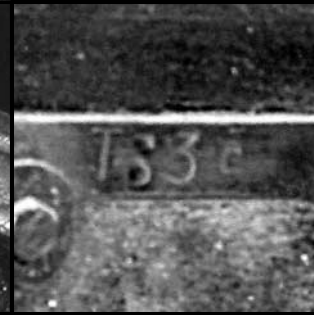
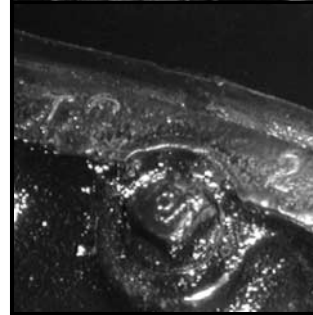
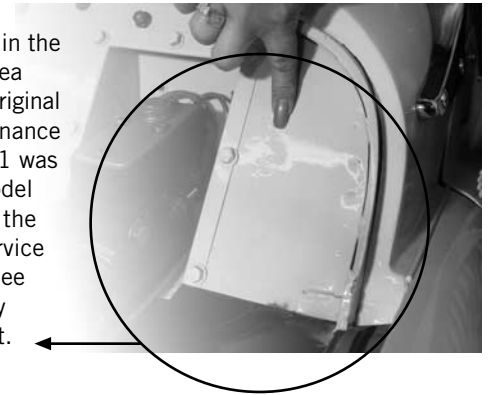
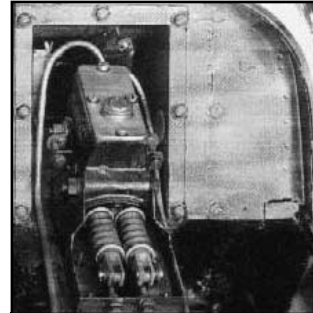

**TS1 ORIGINAL COMPONENTS**

- TS1 rear axle - TS2
- TS1 engine - TS3E
- TS1 transmission - TS4

**TOP & WINDSHIELD**

TS1's original canvas top was used as a template when fabricating tops for both TS1 and TS2. TS1's windshield sits taller than other TR2s creating sealing problems at the bulkhead. The combination of the windshield and canvas top and the fact that no original side curtains could be found, TS1's sidecurtains had to be custom made, created to fit a side opening that is 2" shorter than other TR2s.

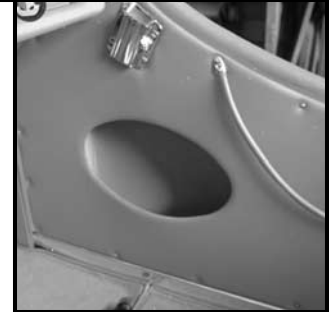

**INTERIOR DIFFERENCES**

- Oval Door pockets
- Seat Frames and springs



### REAR BUMPERS

Smaller and more square than later TRs in the TR2 and TR3 series (an indication of being formed and fabricated by hand).



TS1 rear bumpers

### SPARK PLUGS

Spark plugs use tractor type connectors, unique to TS1 and TS2.

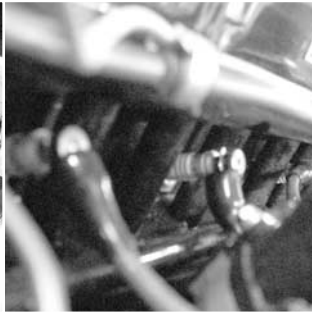

### TS1 FINAL PAINT FINISHES...

Take a close look at the engine compartment upper bulkhead, you will notice that it was painted a more platinum version of white, the car at some point, before completion, was resprayed pearl white, and thus the engine compartment was sprayed out in the flat black to mask the color changes. These paint changes though subtle, are visible in historical photos and the paint was replicated from saved pieces and matched as accurately as possible.



### DISTRIBUTOR CAP

Distributor cap notice the direction of the imprinted LUCAS type.... these caps seem to be original to very early TR2s.

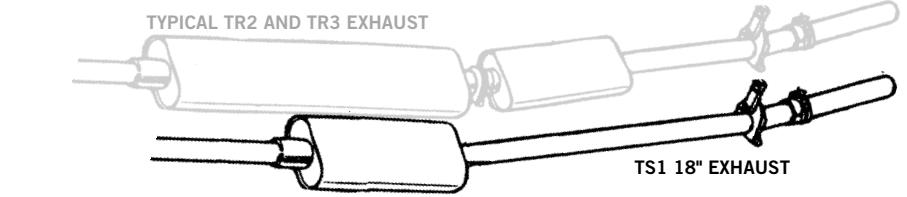

### 18" MUFFLER

This muffler and exhaust system was originally designed for the high audible noise level generally accepted for this type of vehicle, in order to keep the loss of horsepower to a minimum.

The exhaust system was also the victim of a Triumph Service Recall, for many of the early TR2s. The 18" mufflers were replaced with a 24" muffler silencing the cars and lower their horsepower. TS1 has been refitted with the 18" exhaust keeping it original to 1953 prior to the recall.

### UNDERCARRIAGE PAINT

The entire frame, underside and engine compartment of TS1 were painted black.



### ENGINE COMPARTMENT PAINT

Black engine compartment unique to TS1 and TR2.

### CLUTCH CONFIGURATION

The biggest difference is in the friction plate and that the clutch had an unusual throw out bearing.

### GENERATOR

Generator inspection band original to earlier TR2s. The original generator was used in TS1.

